

FASTENING SETS

BEF-810/811

Pipe clamp

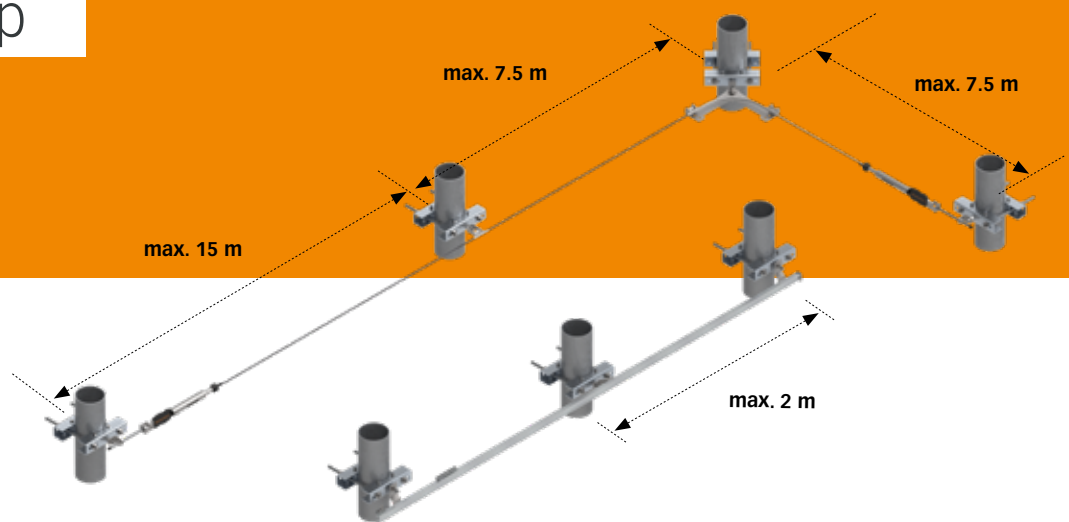

The BEF-810/811 fastening sets from INNOTECH are characterised by their high intrinsic stability. The variable adjustment options for the various clamps

guarantee perfect adaptation to the respective pipe dimensions. The clamps allow rapid and above all perforation-free installation on the respective structures.

- Fastening set for clamping to pipework structures
- The fastening sets can be used in the AIO lifeline system, the TAURUS rail system, and with EAP-SPAR-10-25 as a single anchor point
- With the ABP-10-30, also suitable for abseiling

- Fastening spacings up to 15 m max. are possible
- No penetration of the supporting structure
- Simple and fast installation
- Simple to retrofit at any time

Fastening sets

BEF | FASTENING SETS

BEF-810

FASTENING SETS FOR PIPEWORK STRUCTURES

Material: galvanised steel
Diameter: ø 60 to 120 mm

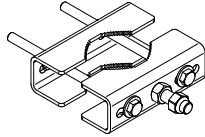

OUR CLAMPS ALLOW RAPID AND PERFORATION-FREE INSTALLATION ON THE RESPECTIVE STRUCTURES.

BEF-811

FASTENING SETS FOR PIPEWORK STRUCTURES

Material: galvanised steel
Diameter: ø 120 to 220 mm

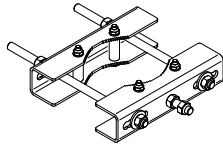

BEF-810-01

FASTENING SETS FOR CORNER PASS-THROUGH ELEMENTS

Substructure: BEF-810, BEF-811, BEF-830-XX
Material: galvanised steel
Connection: Thread M16

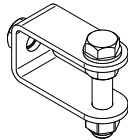

BEF | ASSOCIATED EQUIPMENT

EAP-SPAR-10-25

FASTENING SETS FOR PIPEWORK STRUCTURES

Substructure: AIO-BKS, AIO-/EAP-STA(BIL), AIO-/EAP-SYST, AIO-/EAP-FALZ-45(-15), AIO-/EAP-SAND, steel construction
Usable thread length: 29 mm
Thread: M16 (DIN 933, ISO 4017)
Material: stainless steel (AISI 304)
Not suitable for AIO-VARIO-45/EAP-VARIO-15, EAP-POINT-11/12

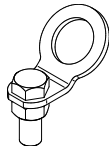

EAP-ABP-10-30

FASTENING SETS FOR PIPEWORK STRUCTURES

Substructure: Steel construction, AIO-STA (up to max. 600 mm length), AIO-SYST, AIO-FALZ-45, steel construction
Usable thread length: 29 mm
Thread: M16 (DIN 933, ISO 4017)
Material: stainless steel (AISI 304)

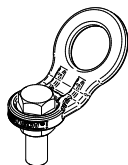

Suitable for abseiling

FASTENING SETS

BEF-830/840/841

I-beam clamp

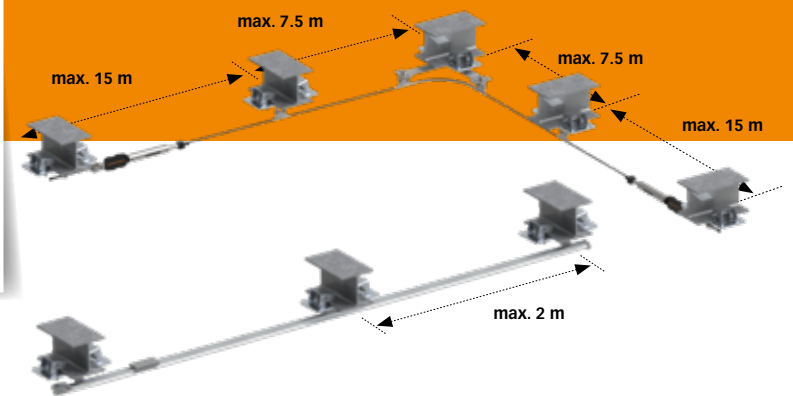

The BEF-830/840/841 fastening sets from INNOTECH are characterised by their high intrinsic stability. The variable adjustment options for the various clamps guarantee

perfect adaptation to the respective beam dimensions. The clamps allow rapid and above all perforation-free installation on the respective structures.

- Fastening set for clamping to I-beams
- The fastening sets can be used in the AIO lifeline system, the TAURUS rail system, and with EAP-SPAR-10-25 as a single anchor point
- With the ABP-10-30, also suitable for abseiling
- Fastening spacings up to 15 m max. are possible
- No penetration of the supporting structure
- Simple and fast installation
- Simple to retrofit at any time

Fastening sets

BEF | FASTENING SETS

BEF-830-01

FASTENING SETS FOR I-BEAM STRUCTURES

Material: galvanised steel
Flange width: 80 to 130 mm

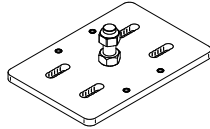

Can only be used in combination with BEF-840/841
Available on request only!

BEF-830-02

FASTENING SETS FOR I-BEAM STRUCTURES

Material: galvanised steel
Flange width: 130 to 180 mm

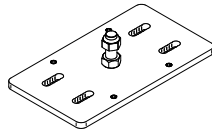

Can only be used in combination with BEF-840/841
Available on request only!

BEF-830-03

FASTENING SETS FOR I-BEAM STRUCTURES

Material: galvanised steel
Flange width: 180 to 260 mm

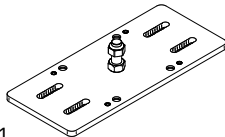

Can only be used in combination with BEF-840/841

BEF-830-04

FASTENING SETS FOR I-BEAM STRUCTURES

Material: galvanised steel
Flange width: 260 to 350 mm

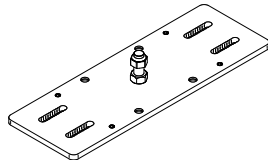

Can only be used in combination with BEF-840/841

BEF-830-05

FASTENING SETS FOR I-BEAM STRUCTURES

Material: galvanised steel
Flange width: 350 to 450 mm

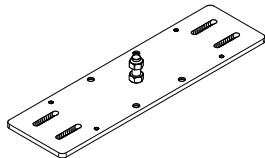

Can only be used in combination with BEF-840/841

FASTENING SETS

BEF-840

FASTENING SETS FOR BEF-830-XX

Material: galvanised steel
Flange width: 8 to 26 mm

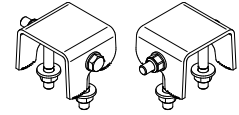

Can only be used in combination with BEF-830-01/02/03/04/05

BEF-841

FASTENING SETS FOR BEF-830-XX

Material: galvanised steel
Flange width: 24 to 40 mm

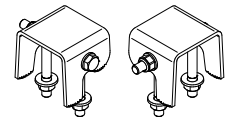

Can only be used in combination with BEF-830-01/02/03/04/05

BEF-810-1

ADAPTER BRACKET FOR CORNER PASS-THROUGH ELEMENTS

Substructure: BEF-810, BEF-811, BEF-830-XX
Material: galvanised steel
Connection: Thread M16

