

SOPV-AERO-EAP



- CZ – POZOR:** Práce s výrobkem INNOTECH je povolena teprve po kompletním přečtení a porozumění bezpečnostních pokynů a návodu k montáži.
- DE – ACHTUNG:** Die Verwendung des INNOTECH-Produkts ist erst zulässig, nachdem die Sicherheitshinweise und Montageanleitung vollständig gelesen und verstanden wurden.
- DK – GIV AGT:** Det er først tilladt at anvende INNOTECH-produktet, efter du har læst og forstået sikkerhedshenvisningerne og monteringsvejledningen.
- EN – ATTENTION:** Use of the INNOTECH product is permitted only after the safety instructions and instruction manual in the respective language have been read.
- ES – ATENCIÓN:** Solo se autorizará el uso del producto INNOTECH una vez que se hayan leído y entendido completamente las indicaciones de seguridad y las instrucciones de montaje.
- FR – ATTENTION :** L'utilisation du produit INNOTECH n'est autorisée qu'après avoir intégralement lu et compris les consignes de sécurité et la notice de montage.
- HU – FIGYELEM:** Az INNOTECH termék használatát csak akkor engedhető meg, ha a biztonságági utasításokat és az összeszerelési utasításokat teljes mértékben elolvasta és megértette.
- IT – ATTENZIONE:** L'utilizzo del prodotto INNOTECH è permesso solo previa lettura completa e comprensione integrale delle avvertenze di sicurezza e le istruzioni di montaggio.
- NL – ATTENTIE:** Dit INNOTECH-product mag pas worden gebruikt nadat u de gebruikershandleiding en de montagehandleiding volledig heeft gelezen en begrepen.
- PL – UWAGA:** Używanie produktu INNOTECH jest dozwolone dopiero po zapoznaniu się z wszystkimi zasadami bezpieczeństwa i instrukcją montażu.
- PT – ATENÇÃO:** O uso do produto INNOTECH apenas é permitido depois de terem sido lidas e compreendidas na totalidade as indicações de segurança e o manual de montagem.
- SK – POZOR:** Použitie výrobku INNOTECH je povolené až vtedy, keď si úplne prečítate a pochopíte bezpečnostné pokyny a montážny návod.
- SL – POZOR:** Uporaba izdelkov INNOTECH je dovoljena šele po tem, ko preberete in so vam jasne vse varnostne opombe in navodila za montažo.
- SV – O B S :** INNOTECH-produkten får inte användas, förrän säkerhets- och monteringsinstruktionerna har lästs igenom och förståtts fullständigt.
- TR – DİKKAT:** INNOTECH ürününün kullanımına ancak güvenlik uyarıları ve montaj talimatı tamamen okunup anlaşıldıktan sonra izin verilir.
- ZH – 注意:** 只有在完全阅读并理解安全提示和装配说明书之后,才允许使用INNOTECH产品。





2



3

3



5

4



8

5



9

6



11

7



13

8



16

9



19

10



20

11



25

12



29

13



30

14



31

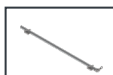

SOPV-AERO-EAP-SET-10

AISI 304
AISI 316
STAINLESS
STEEL

St
STEEL

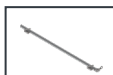
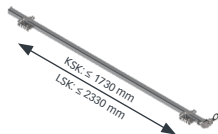

SOPV-AERO-EAP-SET-11

AISI 304
AISI 316
STAINLESS
STEEL

St
STEEL

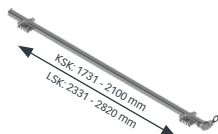

SOPV-AERO-AIO-SET-40

AISI 304
AISI 316
STAINLESS
STEEL

St
STEEL



KSK  SOPV-AERO-EAP-SET-10





SOPV-AERO-AIO-SET-41

AISI 304
AISI 316
STAINLESS
STEEL

St
STEEL



KSK  SOPV-AERO-EAP-SET-11

LSK  SOPV-AERO-EAP-SET-10
 SOPV-AERO-EAP-SET-11

SOPV-AERO-...-SET 



[mm]



SOPV-AERO-VB-SET-10

AISI 304
AISI 316
STAINLESS
STEEL

SOPV-AERO-VB-SET

SOPV-AERO-EAP-SET..

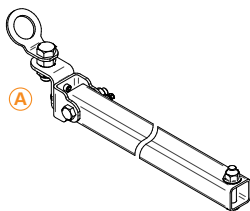

A

B

C

D

E

F

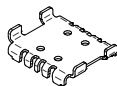

A) 1x | EAP

B) 1x | WEICON AntiSeize ASW 10000

C) 2x | 133,5 x 107 x 34

D) 2x | 96 x 32 x 5

E) 4x | M10 DIN6923

F) 4x | M10 x 70, Typ 28/15

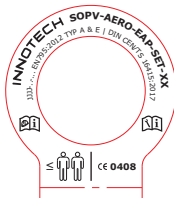



SOPV-AERO-EAP-SET-10

[mm]

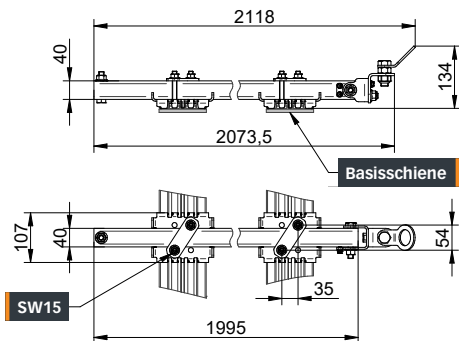

SOPV-AERO-EAP-SET-11

[mm]

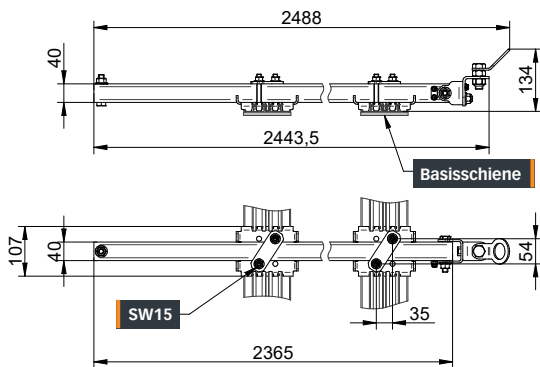

3



[mm]

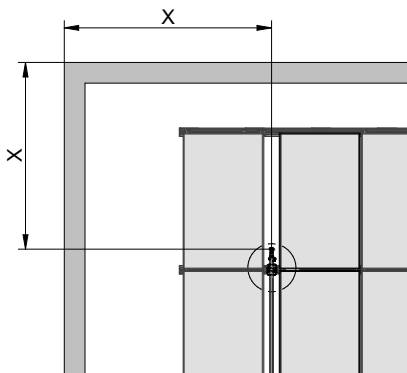
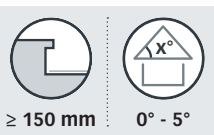
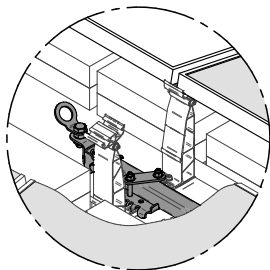
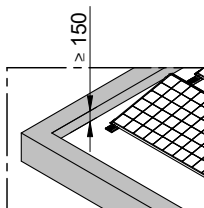

$X =$  AUVA,
DGVU, Suva

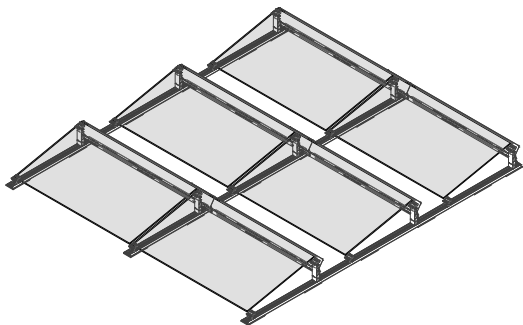

KSK $\geq 3x$
Basisschiene

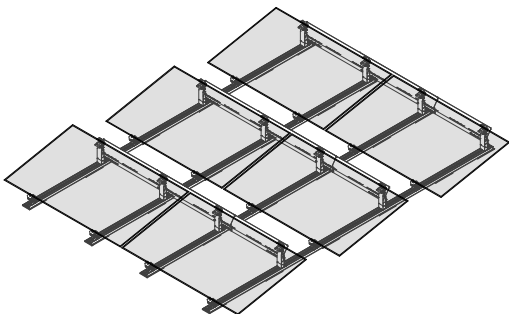

LSK $\geq 4x$
Basisschiene



[mm]

SOPV-AERO-VB-SET-10

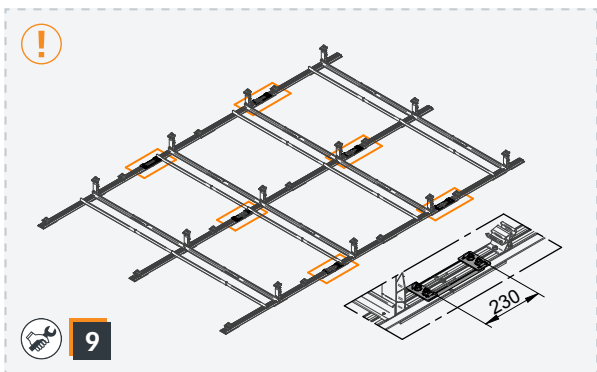
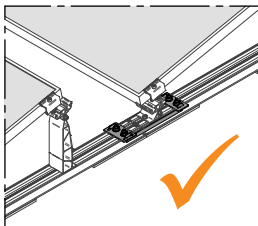
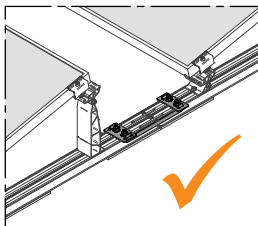
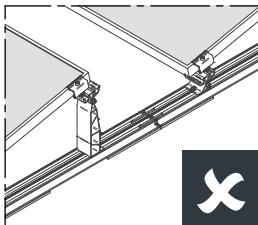
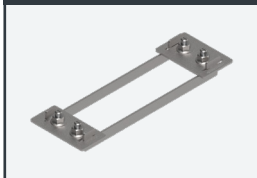

5



KSK | V1



KSK | V2

KSK
V1

[mm]

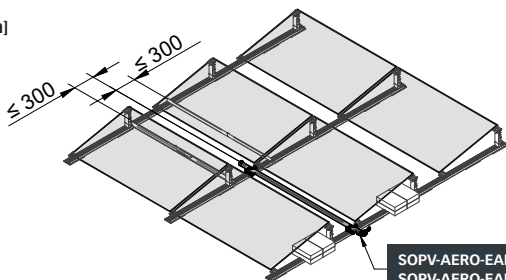
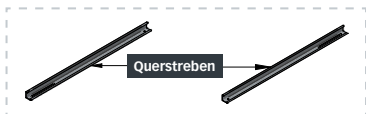
SOPV-AERO-EAP-SET-10
SOPV-AERO-EAP-SET-11

≥ 3x Basisschiene
≥ 2x Querstreben

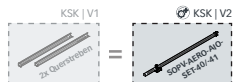

KSK
V2

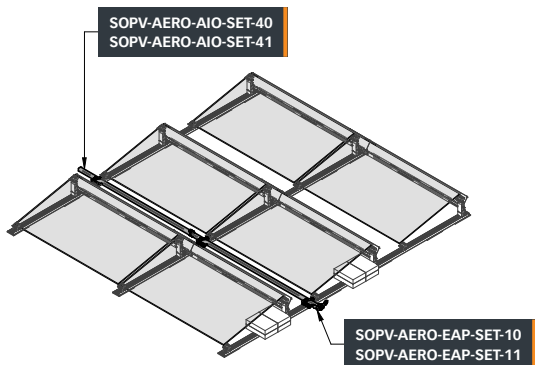

SOPV-AERO-AIO-SET-40
SOPV-AERO-AIO-SET-41

3. Basisschiene

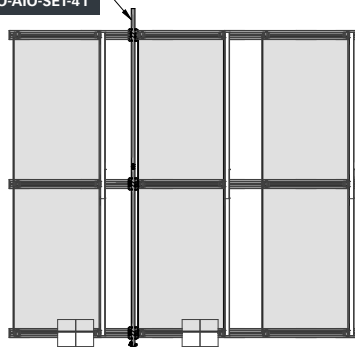

2. Basisschiene

1. Basisschiene

SOPV-AERO-EAP-SET-10
SOPV-AERO-EAP-SET-11

6

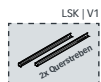
LSK
V1

[mm]

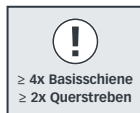
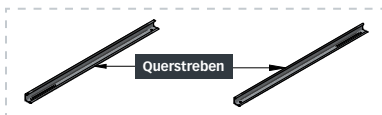
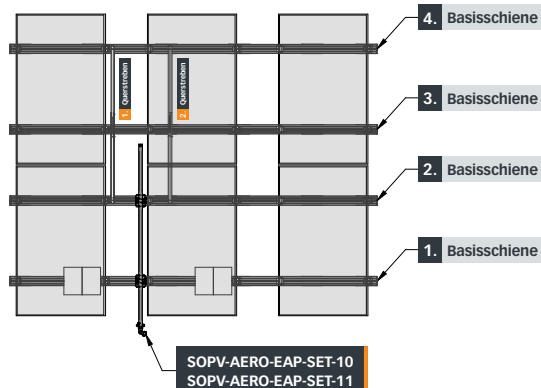
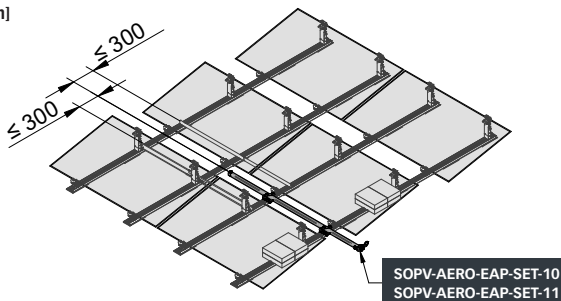

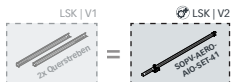

LSK
V2

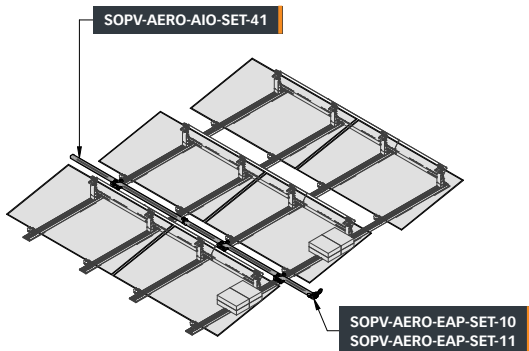

SOPV-AERO-AIO-SET-41

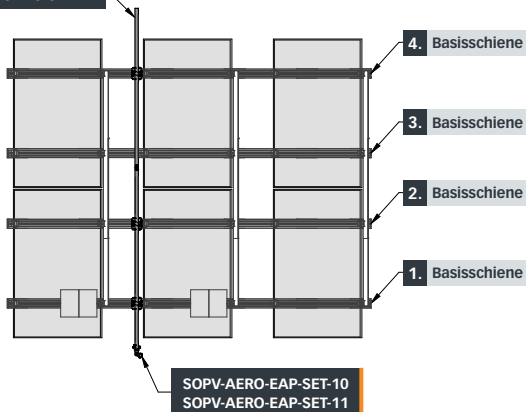

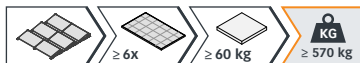

S
SOUTH

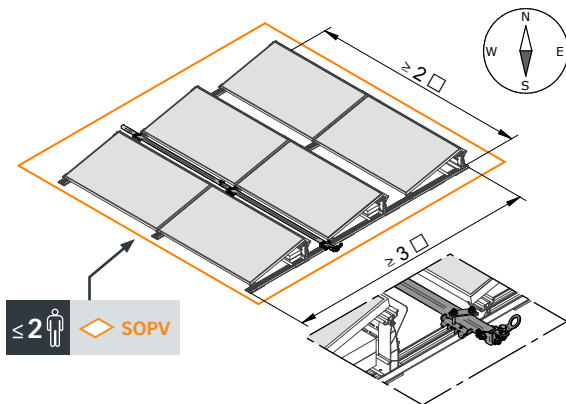

✓ SOPV-AERO-EAP-SET-10
✓ SOPV-AERO-EAP-SET-11

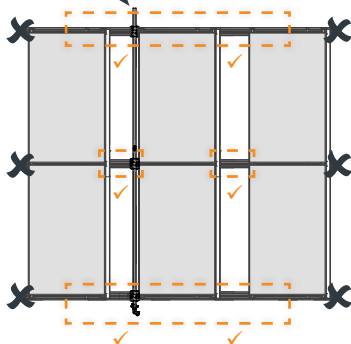
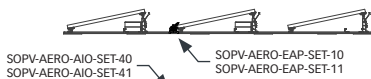

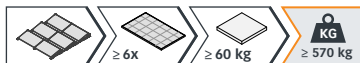

S
SOUTH

[mm]

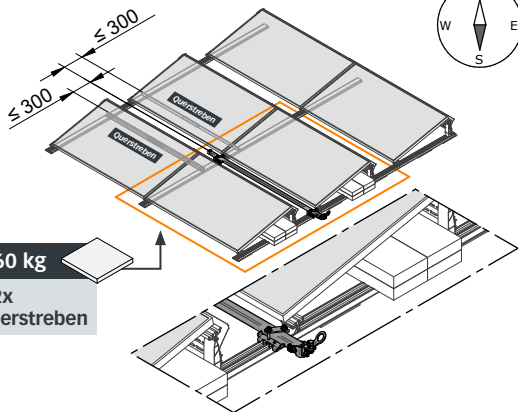

[mm]

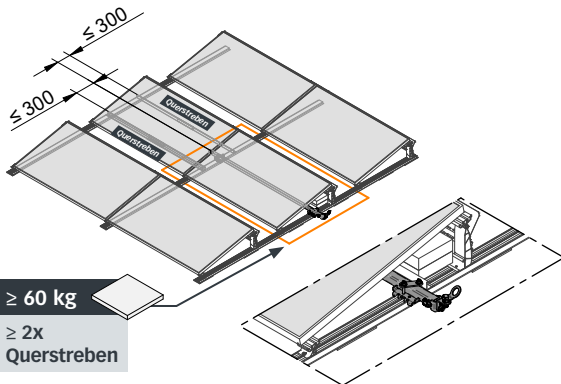

S
SOUTH

[mm]

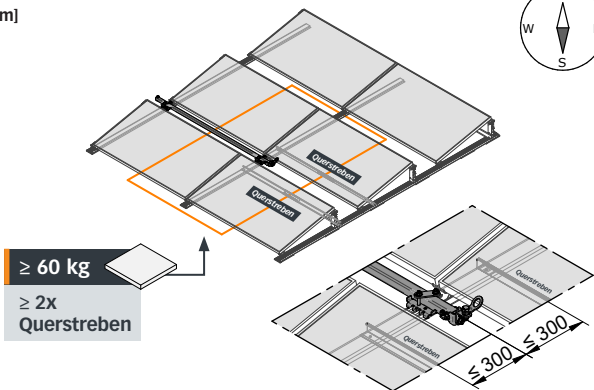

[mm]

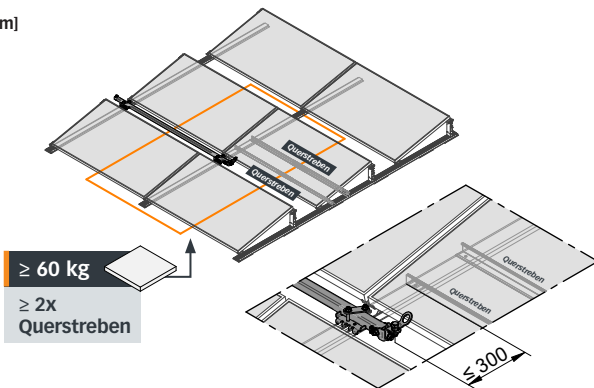

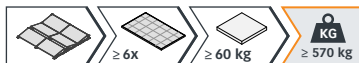

E/W
EAST
WEST

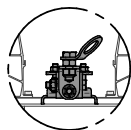
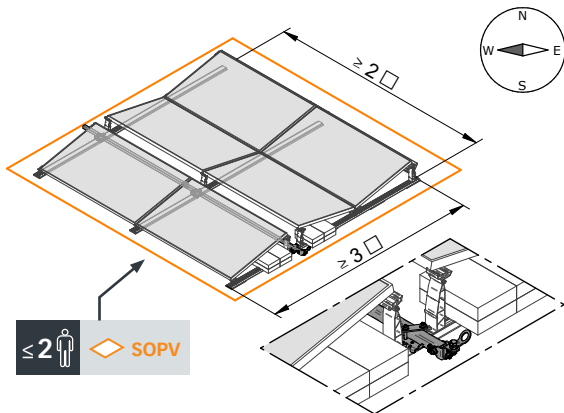

✓ SOPV-AERO-EAP-SET-10
✓ SOPV-AERO-EAP-SET-11

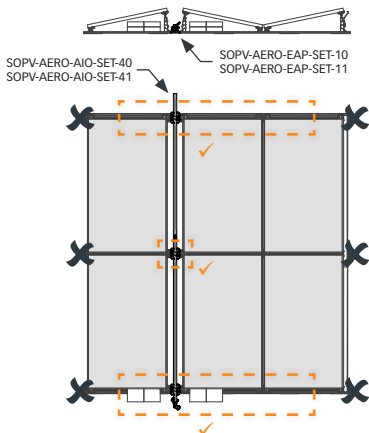

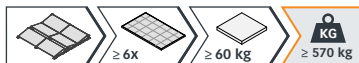

E/W
EAST
WEST

[mm]

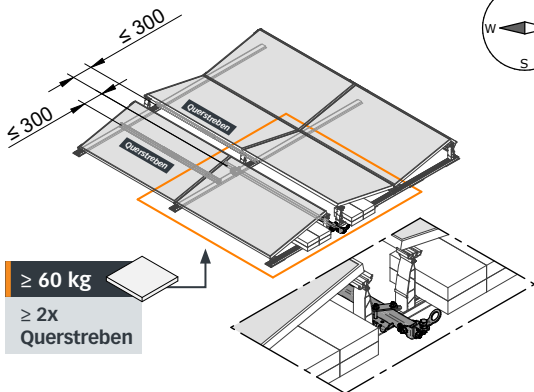

[mm]

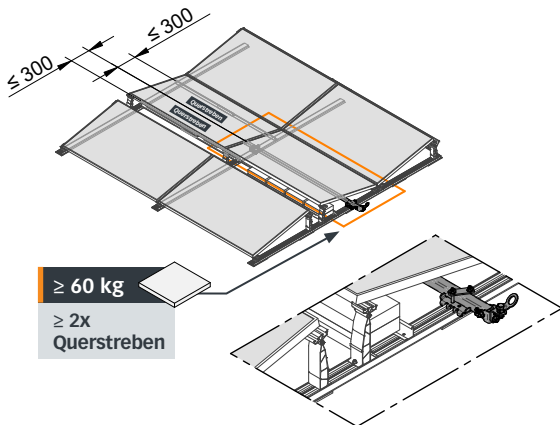

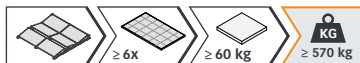

[mm]

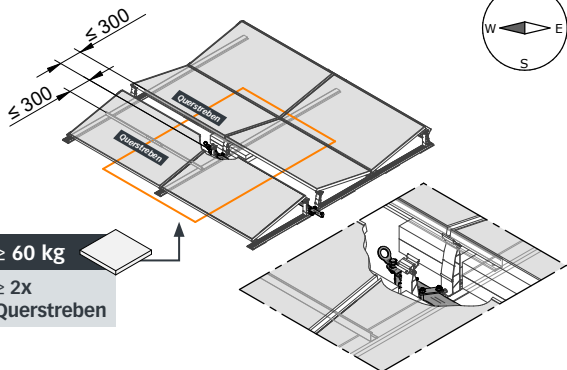

[mm]

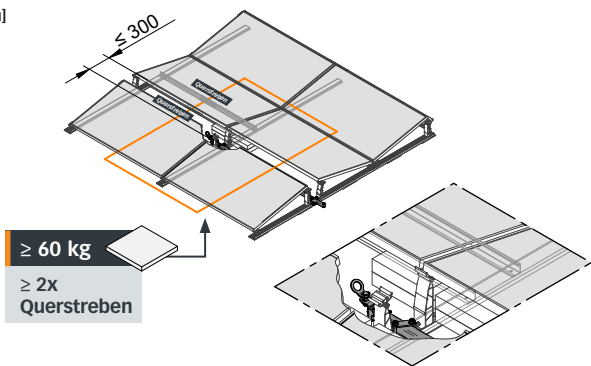



15



30

[mm]

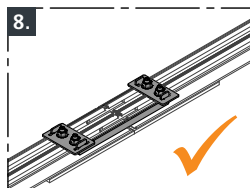
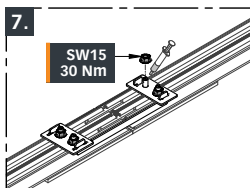
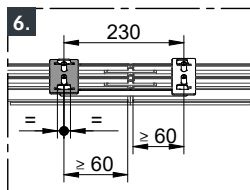
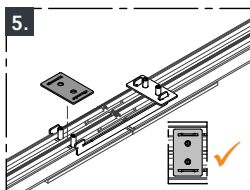
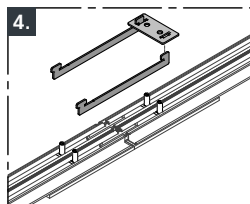
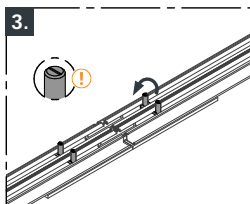
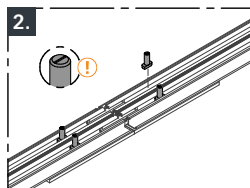
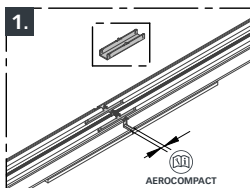



1.

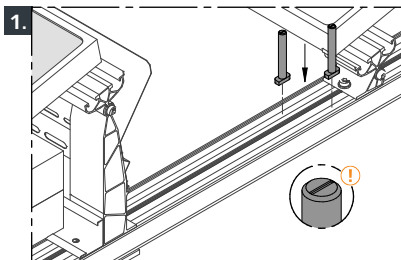

2.

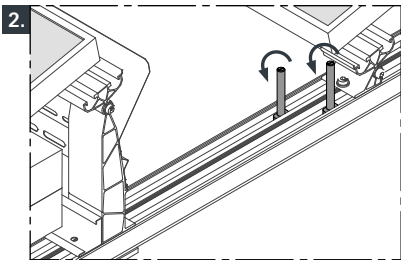

3.

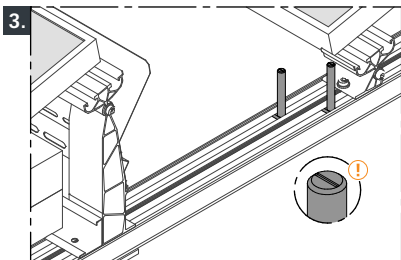



SET-10/-11

SOPV-AERO-EAP-SET-10
SOPV-AERO-EAP-SET-11

4.

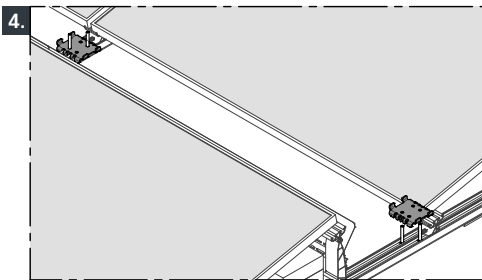
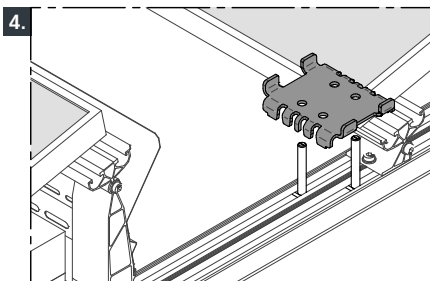

SET-
10/-11SOPV-AERO-EAP-SET-10
SOPV-AERO-EAP-SET-11

5.

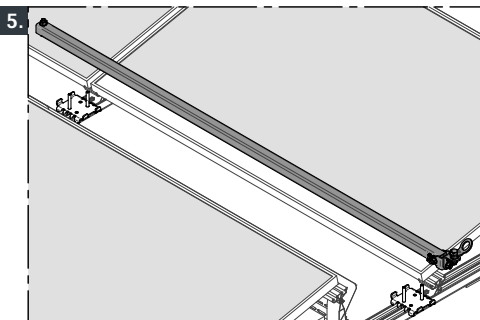
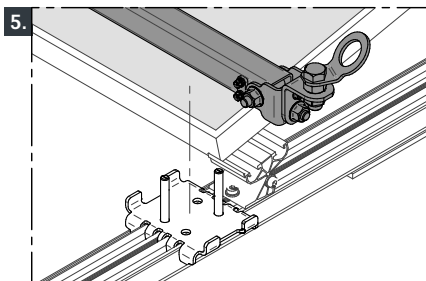



SET-10/-11

SOPV-AERO-EAP-SET-10
SOPV-AERO-EAP-SET-11

5.

KSK

5. KSK

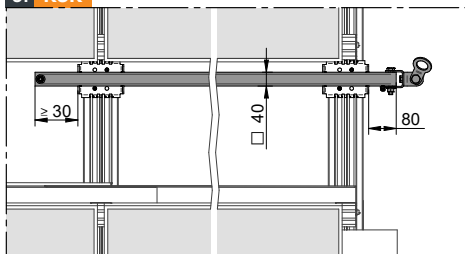

5.

LSK

5. LSK

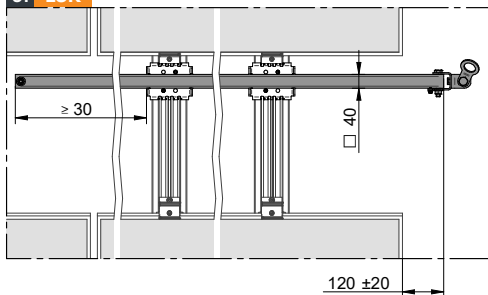



6.

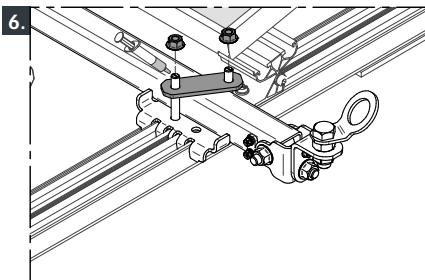

6.

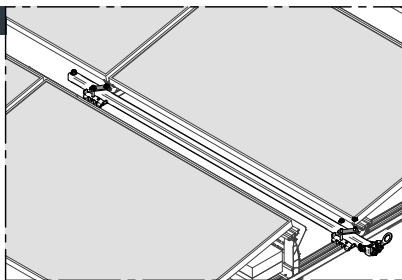

7.



7.

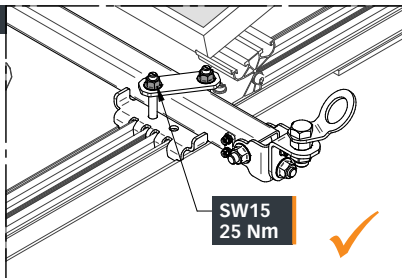



SOPV-AERO-AIO-SET-40
SOPV-AERO-AIO-SET-41



1.

[mm]

SOPV-AERO-EAP-SET-10
SOPV-AERO-EAP-SET-11

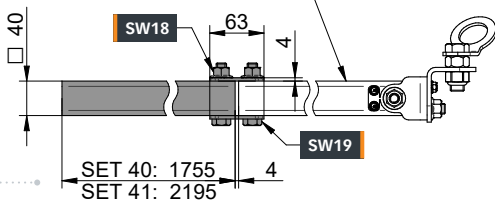

SOPV-AERO-EAP-SET-10
SOPV-AERO-EAP-SET-11

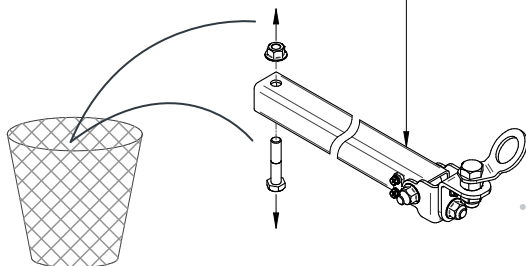

SOPV-AERO-AIO-SET-40

☞ SOPV-AERO-EAP-SET-10

SOPV-AERO-AIO-SET-41

☞ SOPV-AERO-EAP-SET-10

☞ SOPV-AERO-EAP-SET-11



2.

[mm]



19



40



18

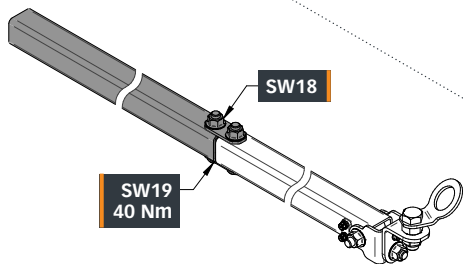
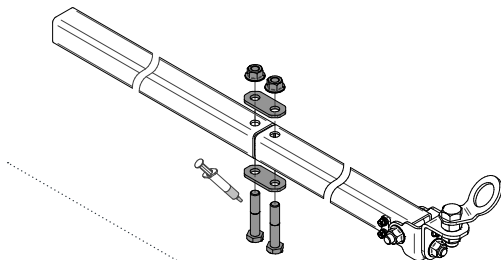



SET-40/-41

SOPV-AERO-AIO-SET-40
SOPV-AERO-AIO-SET-41

3.

[mm]

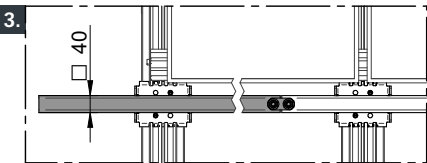
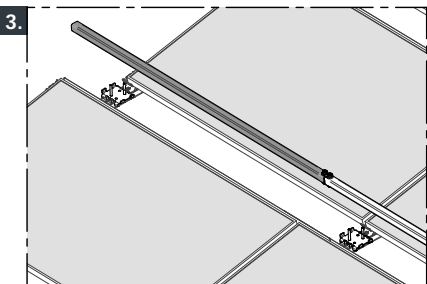
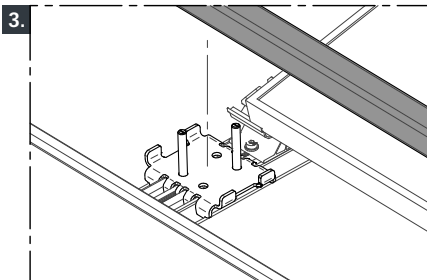



SOPV-AERO-AIO-SET-40
SOPV-AERO-AIO-SET-41

4.

[mm]

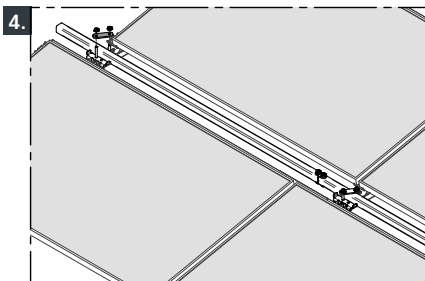
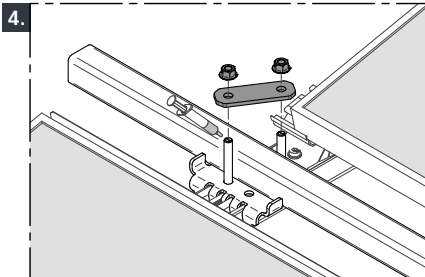

5.

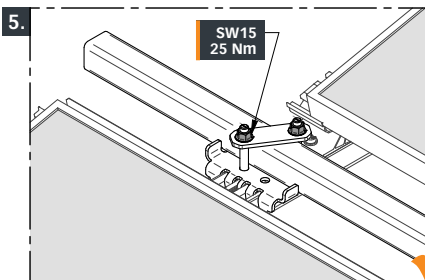

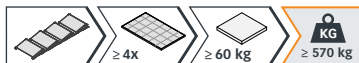

[mm]

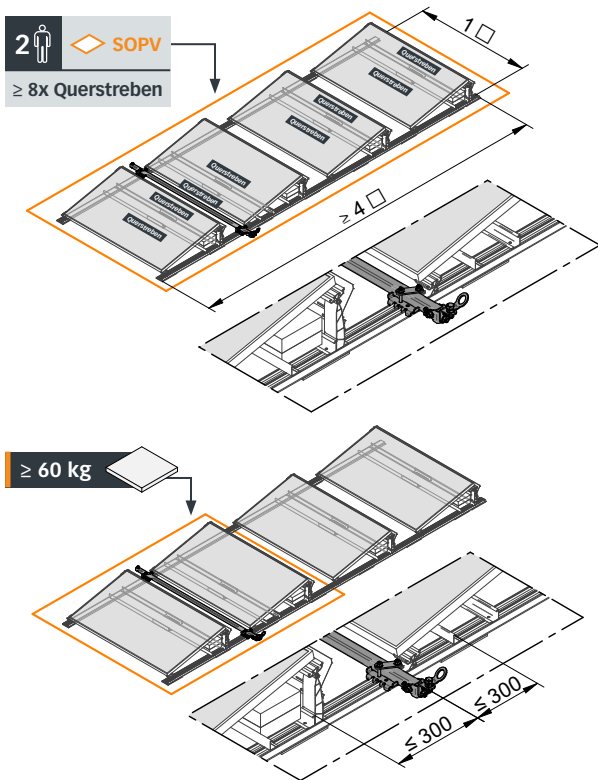

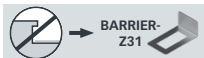

[mm]

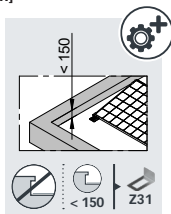

Z31

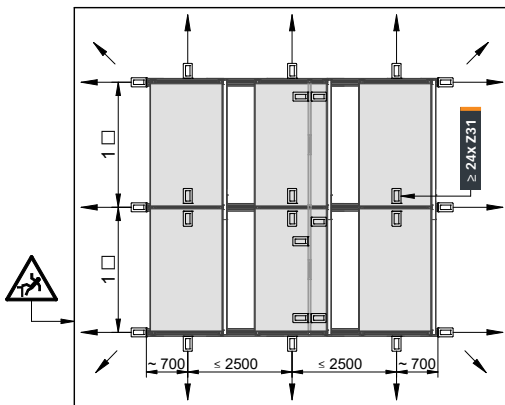
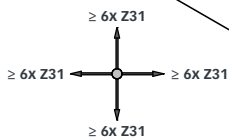
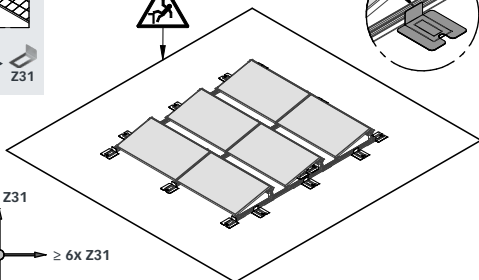
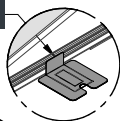

INNOTECH WEB-APP

INNO|doc

Simple. Clear. Document.



www.innotech.at/de/innodoc

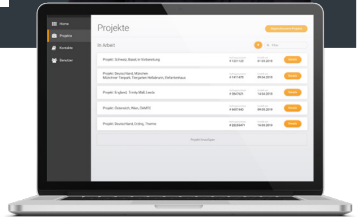

INNOTECH Arbeitsschutz GmbH

Laizing 10, A-4656 Kirchham

T: +43 7619 22122-0

office@innotech.at | www.innotech.at



SOPV-AERO-EAP
www.innotech.at