

# EAP-TEL-10



**CZ – POZOR:** Práce s výrobkem INNOTECH je povolena teprve po kompletním přečtení a porozumění bezpečnostních pokynů a návodu k montáži.

**DE – ACHTUNG:** Die Verwendung des INNOTECH-Produkts ist erst zulässig, nachdem die Sicherheitshinweise und Montageanleitung vollständig gelesen und verstanden wurden.

**DK – GIV AGT:** Det er først tilladt at anvende INNOTECH-produktet, efter du har læst og forstået sikkerhedshenvisningerne og monteringsvejledningen.

**EN – ATTENTION:** Use of the INNOTECH product is permitted only after the safety instructions and instruction manual in the respective language have been read.

**ES – ATENCIÓN:** Solo se autorizará el uso del producto INNOTECH una vez que se hayan leído y entendido completamente las indicaciones de seguridad y las instrucciones de montaje.

**FR – ATTENTION:** L'utilisation du produit INNOTECH n'est autorisée qu'après avoir intégralement lu et compris les consignes de sécurité et la notice de montage.

**HU – FIGYELEM:** Az INNOTECH termék használatá csak akkor engedhető meg, ha a biztonsági utasításokat és az összeszerelési utasításokat teljes mértékben elolvasta és megértette.

**IT – ATTENZIONE:** L'utilizzo del prodotto INNOTECH è permesso solo previa lettura completa e comprensione integrale delle avvertenze di sicurezza e le istruzioni di montaggio.

**NL – ATTENTIE:** Dit INNOTECH-product mag pas worden gebruikt nadat u de gebruikershandleiding en de montagehandleiding volledig heeft gelezen en begrepen.

**NO – OBS:** Bruken av INNOTECH-produktet er først tillatt etter at sikkerhetsinstruksene og monteringsanvisningen har blitt lest og forstått fullstendig.

**PL – UWAGA:** Używanie produktu INNOTECH jest dozwolone dopiero po zapoznaniu się z wszystkimi zasadami bezpieczeństwa i instrukcją montażu.

**PT – ATENÇÃO:** O uso do produto INNOTECH apenas é permitido depois de terem sido lidas e compreendidas na totalidade as indicações de segurança e o manual de montagem.

**SK – POZOR:** Používanie výrobku INNOTECH je povolené až vtedy, keď si úplne prečítate a pochopíte bezpečnostné pokyny a montážny návod.

**SL – POZOR:** Uporaba izdelkov INNOTECH je dovoljena šele po tem, ko preberete in so vam jasne vse varnostne opombe in navodila za montažo.

**SV – O B S:** INNOTECH-produkten får inte användas, förrän säkerhets- och monteringsinstruktionerna har lästs igenom och förstås fullständigt.

**TR – DİKKAT:** INNOTECH ürününün kullanımına ancak güvenlik uyarıları ve montaj talimatı tamamen okunup anlaşıldıktan sonra izin verilir.

**ZH – 注意:** 只有在完全阅读并理解安全提示和装配说明书之后,才允许使用INNOTECH产品。



1



2



3

3



4

4



5

5



6

6



7

7



9

8



11

2

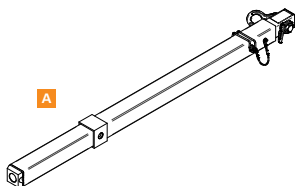

1x



A 1x INNOTECH EAP-TEL-10



.....



3



[mm]

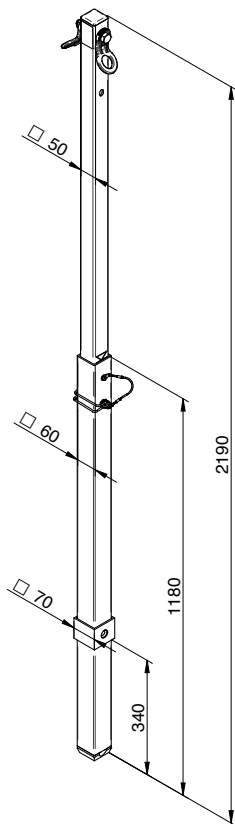
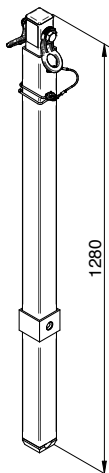
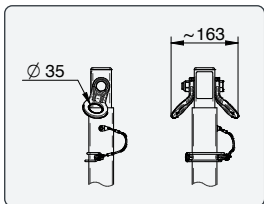

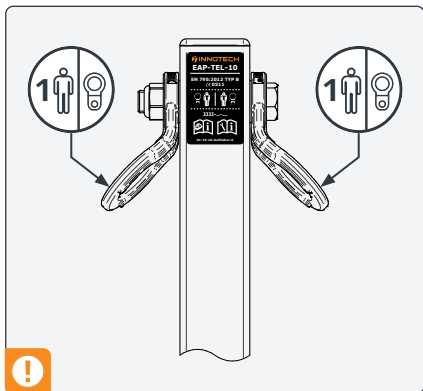
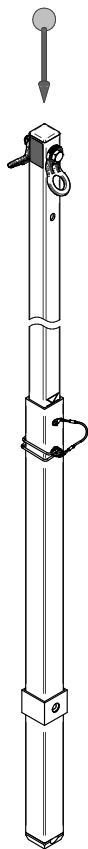

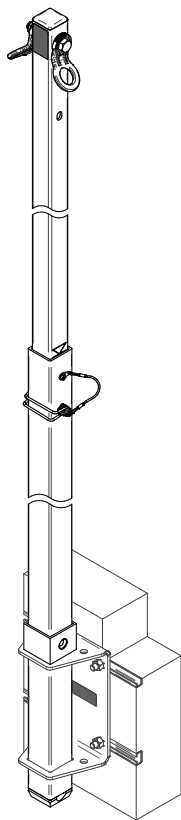

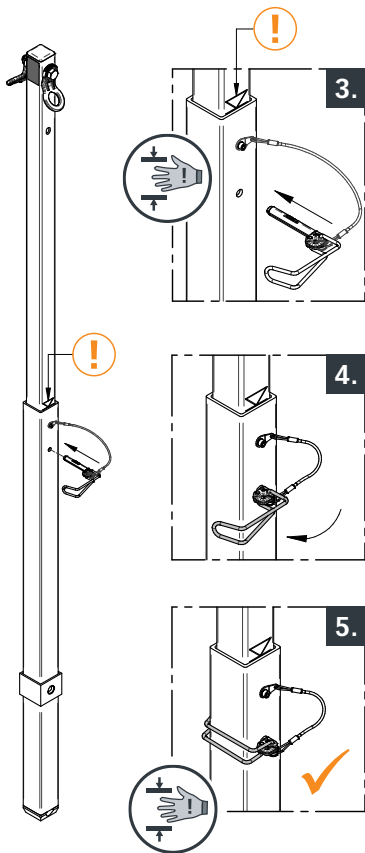
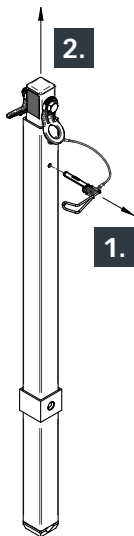

6



6. [mm]

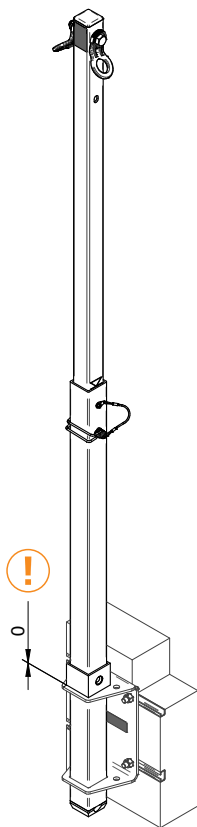
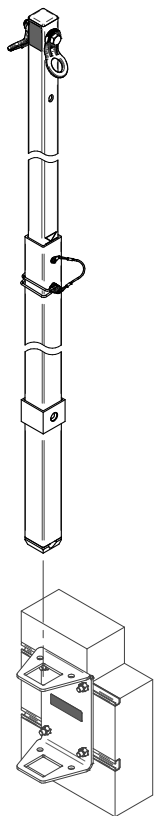



[mm]

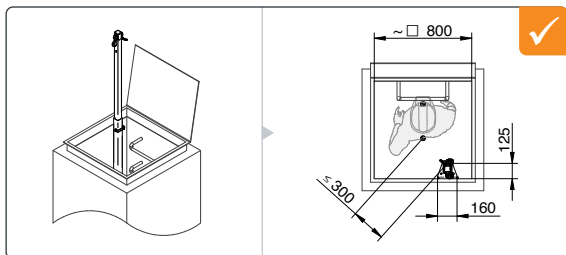
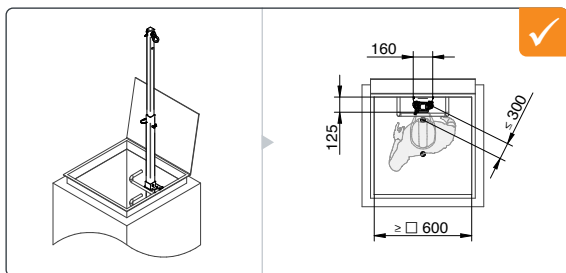
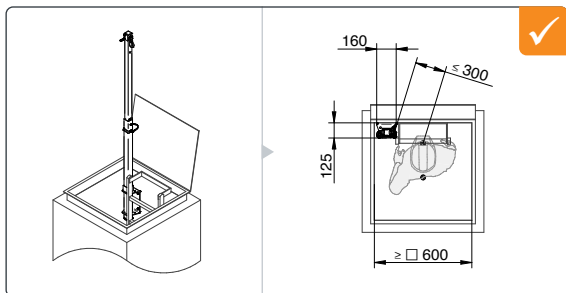



[mm]

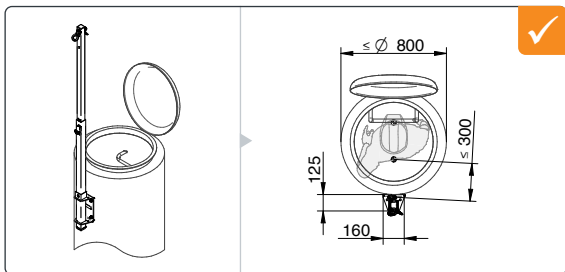
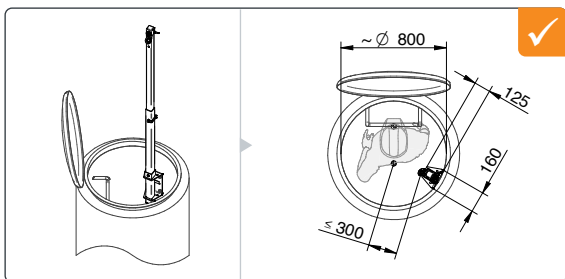
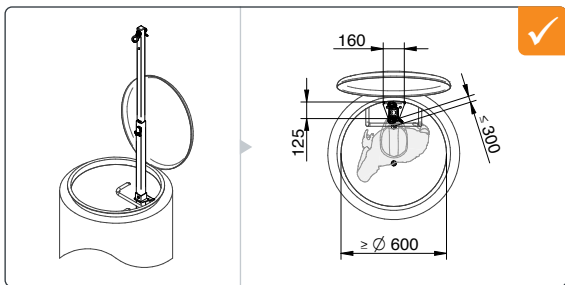

INNOTECH WEB-APP

# INNO|doc

Simple. Clear. Document.



[www.innotech.at/de/innodoc](http://www.innotech.at/de/innodoc)

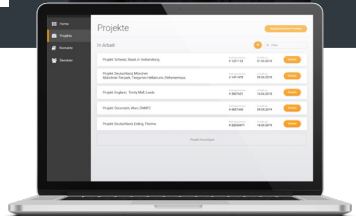

**INNOTECH Arbeitsschutz GmbH**

Laizing 10, A-4656 Kirchham

T: +43 7619 22122-0

[office@innotech.at](mailto:office@innotech.at) | [www.innotech.at](http://www.innotech.at)



EAP-TEL-10  
[www.innotech.at](http://www.innotech.at)